

MAGNETIC TOUCH LATCH (LONG STROKE)

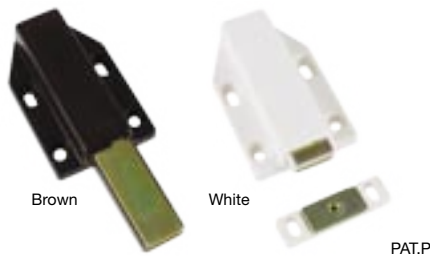

ML-120



- Long stroke for medium size doors.

No.	Part Name	Material	Finish/Color
①	Body	ABS	White, Brown
②	Latch	Steel	Yellow Zinc Chromate
③	Counterplate		

Note: For overlay door, allow a 3.5mm (9/64") gap between door and cabinet frame for pushing space.

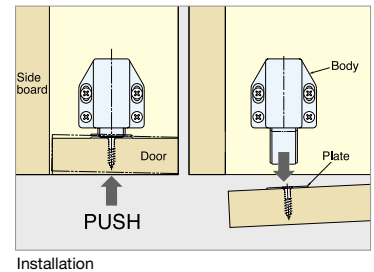
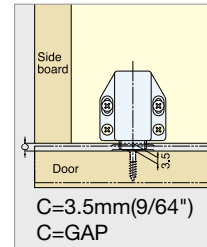
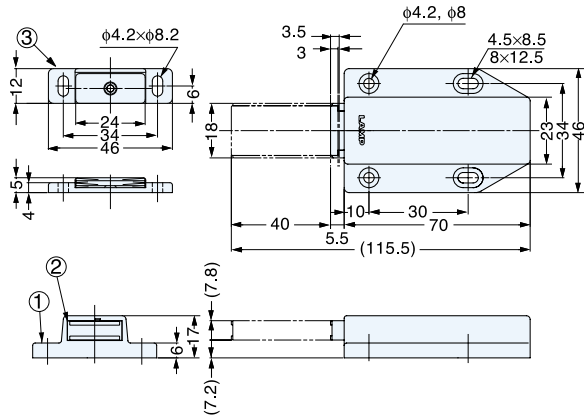

Item No.	Magnetic Force (kg)	Weight (g)	Box (pcs)	Carton (pcs)
ML-120/WHT	2.4 (5.2 lbs)	53	20	200
ML-120/BRN	2.4 (5.2 lbs)	53	20	200

MAGNETIC TOUCH LATCH



ML-80



No.	Part Name	Material	Finish/Color
①	Body	ABS	White, Brown, Black
②	Latch	Steel	Yellow Zinc Chromate
③	Counterplate		

Note: For overlay door, allow a 3.5mm (9/64") gap between door and cabinet frame for pushing space.

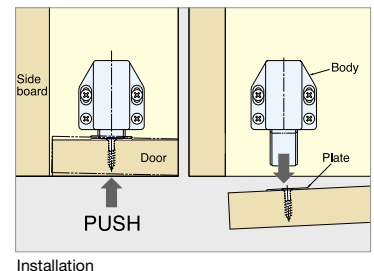
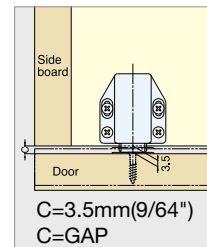
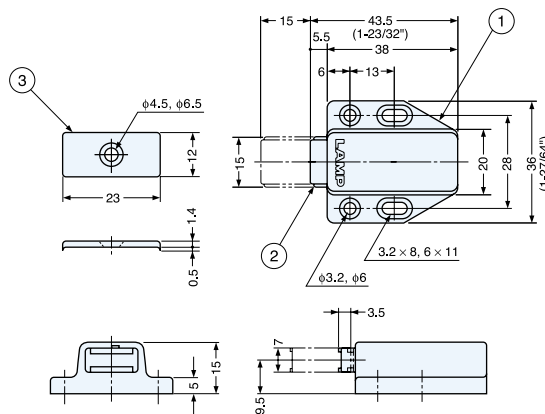

Item No.	Magnetic Force (kg)	Weight (g)	Box (pcs)	Carton (pcs)
ML-80/WHT	1.6 (3.5 lbs)	22	20	400
ML-80/BRN	1.6 (3.5 lbs)	22	20	400
ML-80/BLK	1.6 (3.5 lbs)	22	20	400